

Article number: 20908STM1615AC

Description: E+G Threaded plug DIN 908-ST-M16x15-AC

Measures

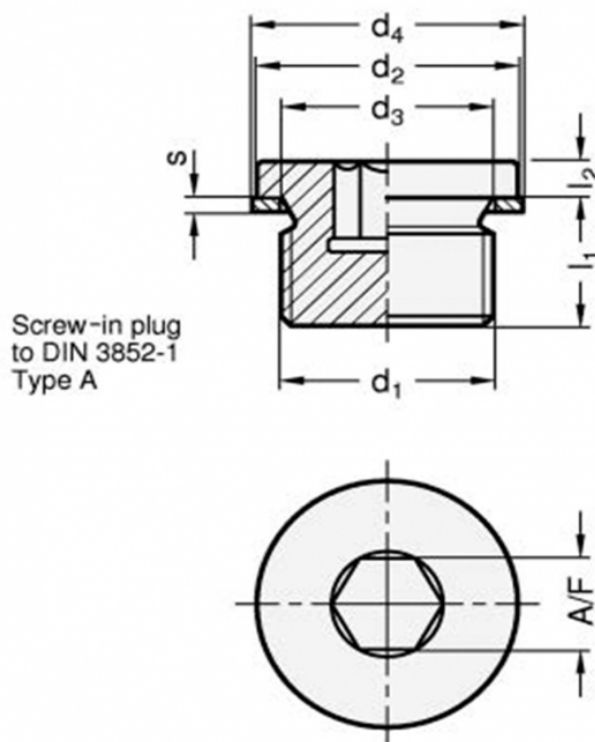

A/F	= 6
d1	= M16x15
d2h14	= 21
d3	= 16.3
d4	= 20
l1	= 12
l2	= 3
s	= 1.5

Weight in (g) = 25